



EXTRUTECH PLASTICS INC.

5902 West Custer Street Manitowoc WI 54220

Phone 920-684-9650 or 888-818-0118

Fax 920-684-4344

P2400 Wall Panel

P1300, P3000 Wall & Ceiling Panels and Trim Details

Please read
Panel Installation Instructions
for Installation Details.

PANELS SLIDE TOGETHER
WITH TONGUE AND GROOVE DESIGN
LEAVING NO EXPOSED FASTENERS
USE RUST PROOF FLAT HEAD
SCREW TYPE FASTNER IN NAILING FIN

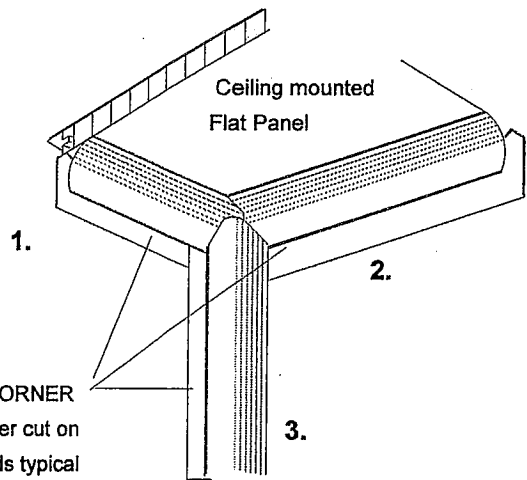

INSIDE CORNER
w/ 3/8" miter cut on
curved ends typical

INSIDE CORNER DETAIL

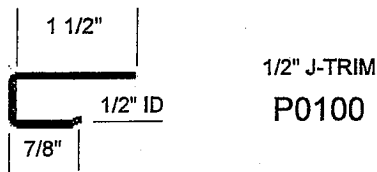
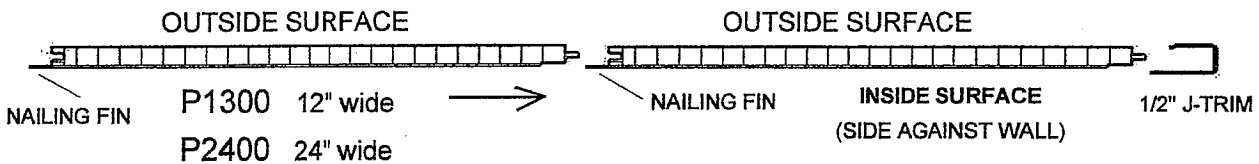

1/2" J-TRIM
P0100

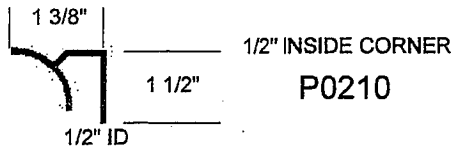

1/2" INSIDE CORNER
P0210

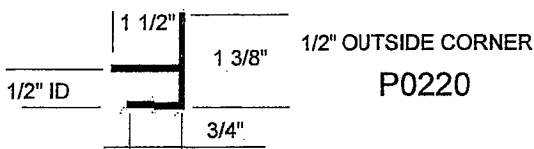

1/2" OUTSIDE CORNER
P0220

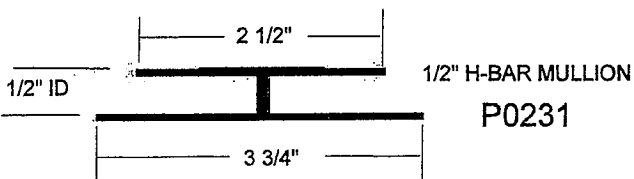

1/2" H-BAR MULLION
P0231
TRIM DETAILS .06 lb / ft.

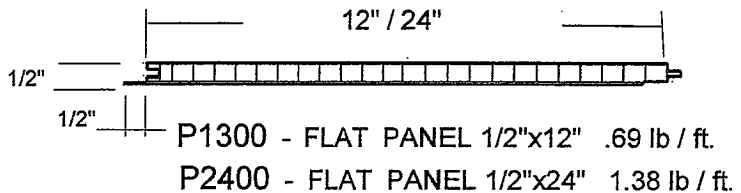

P1300 - FLAT PANEL 1/2"x12" .69 lb / ft.
P2400 - FLAT PANEL 1/2"x24" 1.38 lb / ft.

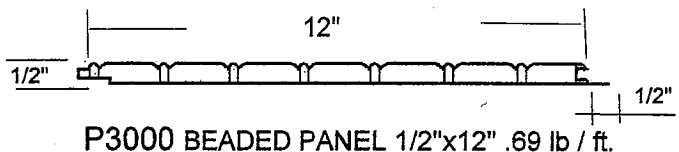

P3000 BEADED PANEL 1/2"x12" .69 lb / ft.

Required Tools

- Hammer Drill, with 5/32" Mason Bit (Masonry installation)
- Wide blade putty knife (used to slip last panel into J-trim)
- Hammer and wood block, (used to snap panels together)
- Caulk gun using PL 400 or Liquid Nails
(trim adhesive for masonry or wood).

Required Fasteners

- MASONRY TAPCON SCREWS 3/16" x 1 1/4" (FLAT HEAD)
with 1/4" Stainless Washers
- WOOD 1 1/4" No 8 Truss Head Sheet Metal Screws
- METAL 3/4" No 8 Truss Head Sheet Metal
or Tek Screws

5902 W. Custer Manitowoc, WI 54220 Phone 920-684-9650 Fax 920-684-4344

www.epiplastics.com e-mail: info@epiplastics.com

